

Data Sheet



Article number: 204903210BMT

Description: E+G Clamp mounting - GN 490-32-10-B-MT

Measures

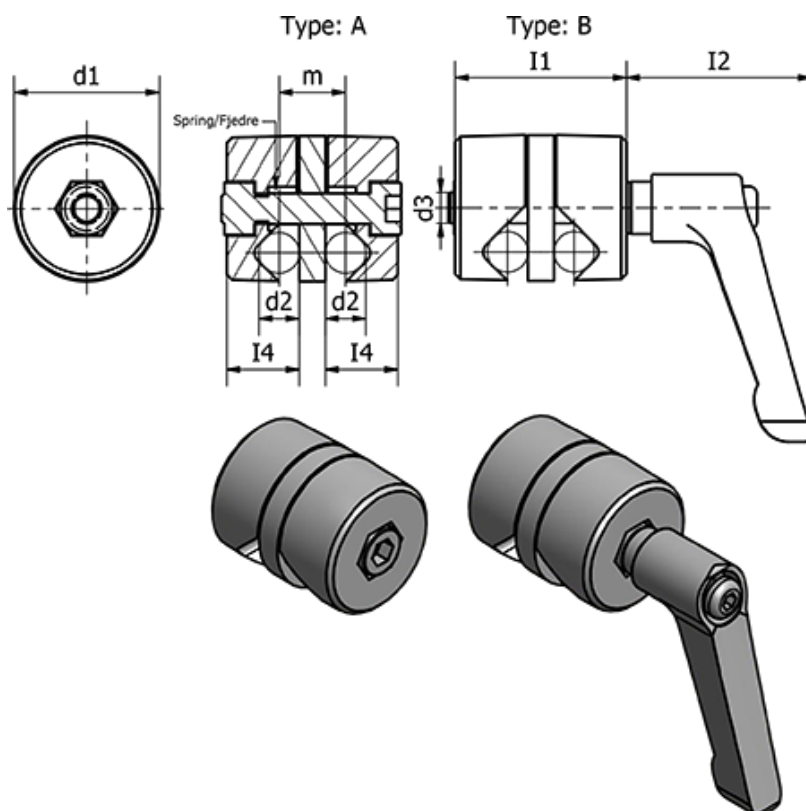

d1 = 32	m = 15
d2 = 10	Weight (g) = 172
d3 = M8	
I1 = 45	
I2 = 45	
I3 = 63	
I4 = 20	
I5 = 5	